

Ing. Markus Giemza

Autoreferát dizertačnej práce

**Use of microwave for energy recovery
from waste**

na získanie akademickej hodnosti doktor (philosophiae doctor,
PhD.)

v doktorandskom študijnom programe: **Elektroenergetika**
v študijnom odbore 5.2.30 Elektroenergetika

Miesto a dátum: Bratislava, 2016

**SLOVENSKÁ TECHNICKÁ UNIVERZITA
V BRATISLAVE
FAKULTA ELEKTROTECHNIKY A INFORMATIKY**

Ing. Markus Giemza

Autoreferát dizertačnej práce

**Použitie mikrovln pri získavaní energie
z odpadu**

na získanie akademickej hodnosti doktor (philosophiae doctor,
PhD.)

v doktorandskom študijnom programe:
Elektroenergetika

Miesto a dátum: Bratislava, 2016

Dizertačná práca bola vypracovaná v externej forme doktorandského štúdia

Na: Ústav elektroenergetiky a aplikovanej
elektrotechniky, Fakulta elektrotechniky
a informatiky
Slovenská technická univerzita v Bratislave

Predkladateľ: Ing. Markus Giemza
Ústav elektroenergetiky a aplikovanej
elektrotechniky, Fakulta elektrotechniky a
informatiky, Slovenská technická univerzita v
Bratislave

Školiteľ: doc. Ing. Pavel Timár, CSc.
Fakulta elektrotechniky a informatiky
Slovenská technická univerzita v Bratislave

Oponenti:

Autoreferát bol rozoslaný:

Obhajoba dizertačnej práce sa koná:

Na Fakulta elektrotechniky a informatiky,
Slovenská technická univerzita v
Bratislave, Ilkovičova 3

dekan FEI STU

TABLE OF CONTENT

Thesis and purpose of the dissertation	6
1. Introduction	7
1.1. Background.....	7
1.2. Legislative situation in waste management.....	7
2. Ways to recover energy from waste	8
2.1. Anaerobic Digestion.....	8
2.1.1. Biogas.....	8
2.1.2. Pre-treatment prior to anaerobic digestion	8
2.1.3. Disintegration as a method to increase biogas yield.....	9
2.2. Incineration of waste	9
2.3. Pyrolysis and gasification (ATT).....	10
2.3.1. Advantages and drawbacks of ATT.....	10
2.3.2. Potential significance of MW in ATT.....	11
3. Microwave theory	11
3.1. Interaction of microwaves with matter.....	11
3.2. Dielectric heating	12
3.2.1. Permittivity	12
3.2.2. Penetration depth	13
3.3. Microwave effects	14
4. Methods used in the dissertation.....	15
4.1. Microwave application for sewage sludge pre-treatment	15
4.2. Gasification and oxidation experiments.....	15
4.2.1 Oxidation of exhaust gases using reactor MOS.....	17
5. Results of sewage sludge pre-treatment.....	18
5.1. Energy considerations.....	19
6. Results of gasification and oxidation	20
6.1. Scrap tires gasification	20
6.2. Biomass gasification (sawdust and wood pellets)	21
6.3. Gasification of different waste samples.....	22
6.3.1 Oxidation and cleaning of exhaust gases	23
6.3.2 Discussion of the results.....	24
6.4. Oxidation of different gas components by reactor MOS	25
7. Conclusions.....	27

7.1.	Potential of microwave-pre-treatment of sludge to increasing of the biogas yield of the digestion process	27
7.2.	Potential of microwave gasification for energy recovery from waste.....	28
7.3.	Potential of microwave indirect heating to energy recovery and to cleaning of exhaust gases	29
8.	Summary.....	30

Thesis and purpose of the dissertation

The aim of the work is to investigate some chosen applications of using microwaves in respect to energy recovery from waste. In order to examine the potential of microwave technology in this area, three main approaches are explored: MW sludge pre-treatment, MW gasification and MW indirect heating of gases.

Following questions are evaluated in the thesis:

- 1. Is microwave pretreatment of sludge useful to increasing of the biogas yield of the digestion process?**
- 2. Is microwave gasification a suitable process for energy recovery from investigated wastes?**
- 3. Is microwave indirect heating suitable to energy recovery from the exhaust gases and in addition also to cleaning of exhaust gases?**

1. Introduction

1.1. Background

Due to high living standard of many industrial countries a great amount of waste is generated. The nature of waste itself is changing; partially due to the remarkable grow in the use of hi-tech products. Therefore waste now contains an increasingly complex mix of materials, including precious metals and hazardous materials that are difficult to deal with safely. The waste generation has a serious impact on the environment, causing pollution and greenhouse gas emissions, as well as significant losses of materials – a particular problem for the EU which is highly dependent on imported raw materials [1].

In the EU-27 countries in 2012 was generated over 244 million tonnes municipal solid waste, which makes up around half a tonne per each inhabitant on average. According to the estimation of European Commission for the period between 2006 and 2010, about 10 million tons DM of sewage sludge is generated each year [2].

A serious threat to the natural environment is also the increasing numbers of used tyres, of which more than 17 million tonnes are produced globally each year. Scrap tires are highly resistant to biodegradation, photochemical decomposition, chemical reagents and high temperatures, and have differing chemical compositions. The restrictive EU legal regulations have led to solutions enabling rubber wastes to be converted into energy or new polymer materials [3].

1.2. Legislative situation in waste management

The **Waste Framework Directive 2008/98/EC** (WFD) is one of the most important documents of waste policies and legislations in Europe. This directive defines a hierarchy of waste to minimize adverse effects from waste on the environment and to increase resource efficiency in waste management and policy [4].

The **Landfill Directive** (Council Directive 1999/31/EC) defines the requirements for landfilling of waste with the intention to reduce negative landfilling effects on human health and the environment [5].

The **Incineration Directive** (2000/76/EC) is the next significant regulation that does not apply only for incineration but also for pyrolysis and gasification also known as Advanced Thermal Treatment (ATT). This Directive defines conditions for operation and monitoring as well as technical requirements and limits emissions to air and discharges to water. The intention of the **End-of-Life Vehicles (ELV) Directive** 2000/53/EC is to support reuse of vehicle and their components, recycling and recovery and to minimise the landfilling of

vehicle waste. This Directive bans some heavy metals from use in new vehicles to improve recycling and processing [6].

All these rules will cause that waste will be sorted stricter in the future and the landfilling will become increasingly difficult and costly. This development will lead to decrease of the incineration of unsorted waste and increase of waste sorting and alternative solutions such as gasification and anaerobic digestion.

2. Ways to recover energy from waste

There are three common ways to recover energy from waste:

- **Anaerobic digestion** – decomposition of organic matter by microorganisms in the absence of oxygen.
- **Incineration** - direct combustion
- **Thermal decomposition** - Pyrolysis / Gasification.

2.1. Anaerobic Digestion

Anaerobic digestion (AD) is a well-established method to production of renewable energy from different waste biomass. The most important advantage of using AD is the generation of energy from a feedstock that would otherwise contribute to climate change through methane production in landfill. Methane is considered as one of the most significant greenhouse gases, because its Global Warming Potential averaged over 100 year is 21 higher than of the same mass of CO₂ [7].

2.1.1. Biogas

The biogas is a gas mixture that mainly consists of methane (50-75%), carbon dioxide (25-45%), water vapour (2-7%) and traces of other gases (oxygen, nitrogen, ammonia and hydrogen sulphide). The energy content of biogas depends on the methane content. If the average content of methane is at 60 %, then the energy value of one cubic metre of biogas is about 6 kWh (21,6 MJ/m³), which corresponds to about 0.6 litres of heating oil [59]. The biogas yield of the AD is depending on the process and is between 80 and 150 m³ from one tone waste. The biogas can be directly burned to produce heat or be used as an engine fuel for Combined Heat and Power (CHP) systems. After removing of undesired components the methane can be fed into national gas grid, what in consequence displaces natural gas and contribute to reducing of GHG emissions [8].

2.1.2. Pre-treatment prior to anaerobic digestion

There are some organic substances, which can be decomposed by anaerobic digestion, but the process needs very long time and biogas production is not efficient. The reason

could be among others the molecular structure, presence of chemical substances and physical problems like clumping, floating or foaming, blocking of pipes and impellers of biogas plants [9].

2.1.3. Disintegration as a method to increase biogas yield

Disintegration is a stressing of sludge by external forces using physical, chemical or biological processes. The aim of disintegration is reduction of the sludge amount, improvement of the dewatering, increasing the efficiency of biogas production and optimizing other processes of wastewater treatment (for example denitrification) [10].

The process of anaerobic digestion is limited by the rate of hydrolysis. Hydrolysis is a transformation of the polymerized, mostly insoluble organic compounds to soluble monomers and dimers [11]. The conventional process can rarely achieve the decomposition rates of organic sludge fraction of more than 50%. Disintegration can significantly accelerate the hydrolysis by decomposition of the flock structure and the release of exoenzymes [12]. Practical tests in the commercial scale have shown, that this method can increase the amount of biogas by up to 30%, in addition to many other positive effects, like reduction of foaming and decrease of sludge amount [10].

2.2. Incineration of waste

Incineration with energy recovery is one of the most common waste treatment methods and processes in average 23 % of the total MSW generation in Europe [13]. Many incinerators have a very low efficiency and the compliance to WFD provides a need for large investments. In the most incineration plants raw municipal waste is combusted, without any preparation and sorting.

Incinerators operate with high air excess and temperatures between 850 and 1200 °C, so that all pollutions are completely oxidized. The combustion of one tone of MSW can generate up to 6000 m³ flue gases that must be expensively cleaned [14]. The non-combustible waste components, such as minerals, metals and glass, will remain as a solid, known as bottom ash [15]. The bottom ash is approximately 10 % by volume and 20 to 30 % by weight of the solid waste input [16]. The non-magnetic metal in waste such as copper and aluminium, are oxidized, therefore the recovery rate is very low and the quality of the metal remains in the bottom ash is bad. Iron scrap, which is still in the waste after the magnet separation (about 30 %) and is after combustion recovered from the bottom ash, has a poor quality and is usually polluted with many hazardous substances (dioxins, furans, heavy metals etc.) [17].

The study “Recycling versus incineration: an energy conservation analysis” made in 1996 by MORRIS [18] has demonstrated that incineration is an inefficient way to produce energy, because energy recovery from incineration is lower than energy savings derived from waste recycling (recycling saves more energy than can be generated by incinerating).

2.3. Pyrolysis and gasification (ATT)

Pyrolysis is the thermal-chemical decomposition of carbon-based (organic) materials at high temperatures (between 300°C and 850°C). Pyrolysis is the first step in gasification and combustion and occurs in absence or nearly absence of oxygen [19]. Pyrolysis is maybe the oldest process of conversion of biomass to a higher-grade fuel known as charcoal, which is a fuel with nearly double the energy density of the initial material and burn at higher temperature [20]. By pyrolysis occur a syngas (synthesis gas) and a solid residue, which consist of non-combustible components and carbon. The synthesis gas is a mixed gas of different combustible components such as carbon monoxide, hydrogen, methane and a wide range of other VOCs. A part thereof can be condensed to produce oils, waxes and tars. The synthesis gas typically has a caloric value (LCV) from 10 to 20 MJ/Nm³.

Gasification is also a thermal-chemical degradation of substance, similar to pyrolysis, however that involves the partial oxidation, therefore it can be considered as a process between pyrolysis and combustion [15]. In the gasification the amount of oxygen is not sufficient to allow the fuel be completely oxidised. The process temperatures employed are usually higher than 650°C. Gasification is a largely exothermic procedure but some heat may be required to initialise and sustain the gasification process. The main product is syngas with a lower caloric value (CV under 10 MJ/Nm³). A solid residue of gasification contains usually less carbon than that of the pyrolysis.

2.3.1. Advantages and drawbacks of ATT

In pyrolysis and gasification in addition to heat other products can occur such as syngas and pyrolysis oils. Syngas can be cleaned and burnt in gas engines or gas turbines to produce electricity with better efficiency, or be converted into transport fuels or other products. Due to lower temperatures than those of direct combustion, the potential of alkali and heavy metal volatilization is reduced. Because of the reducing atmosphere, emission of dioxins and furans are lower. The deficit of air reduces heat losses at the stack and thus increases energy recovery efficiency. Most of the non-combustible material is collected at the bottom of the reactor with metals mainly in a non-oxidized form [21].

On the other hand, gasification and pyrolysis produce also some undesirable by-products like fly ash, tar and char. In particular tar is responsible for many technical problems in

ATT plants [22]. Syngas has some problematic characteristics that complicate the application, such as toxicity and explosion hazard. In addition, an expensive cleaning and conditioning of syngas is often necessary, which increases the operation costs and decreases the overall efficiency of gasification plants [21].

2.3.2. Potential significance of MW in ATT

Due to specific effects of microwave irradiation and different interaction mechanisms with materials this technology may be advantageous in energy recovery from waste by gasification. The positive experiences in the chemical industry (microwave chemistry) and food industry may indicate that microwave application can be interesting approach even in the ATT. The thesis deals with the applications of microwave technology in ATT and describes different experiments with gasification of different types of waste.

3. Microwave theory

Microwaves are electromagnetic waves in the frequency range between 0.3 and 300 GHz, with corresponding wavelengths between 10 mm and 1 m. For the industry heating applications are used die microwave frequencies 915 MHz, 2.45 GHz and 5,8 GHz.

For most practical applications of microwave technology is the electric component of the electromagnetic field more important for wave–material interactions, although in some processes magnetic field interactions (e.g. with transition metal oxides) can also be of relevance [23].

3.1. Interaction of microwaves with matter

Microwaves can be transmitted nearly without absorption through some dielectric materials, reflected by metallic objects and absorbed by other dielectric materials (see Figure 1). Good microwave absorbers are water, carbon, and foods with high water content, whereas materials such as most ceramics and thermoplastic materials absorb microwaves only slightly.

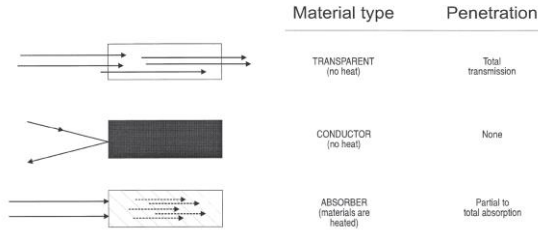

Figure 1: Interaction of different materials with microwave radiation [24]

In the most cases in practise the material interaction is a combination of transmission, reflexion and absorption or at least two of these effects, but one of them is usually strongly dominant. However, many materials completely change its behaviour during the heating process [25].

3.2. Dielectric heating

Thermal microwave applications are mainly based on the heating of materials by dielectric heating effects, which are caused by the electric component of an electromagnetic field. Microwaves generate heat, when the particles of irradiated substance are charged (possess a dipole moment). By the exposure to microwave field the dipoles try to align in the applied electric field. As the field oscillates, the dipole field attempts to realign itself with the alternating electric field and, in the process, energy in the form of heat is lost through molecular friction and dielectric loss. The principle of microwave heating of water is illustrated in Figure 2 [26].

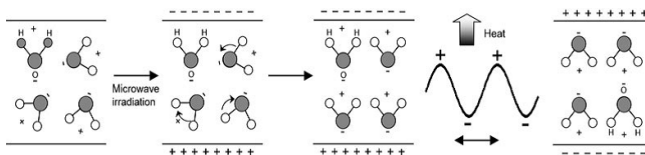

Figure 2: Principle of microwave dielectric heating [26]

The efficiency of heating by microwave irradiation depends dielectric properties of materials, temperature and frequency.

3.2.1. Permittivity

The interaction between dielectric and microwaves for non-magnetic and low conductive materials describes the permittivity. The relative permittivity was defined by M. Faraday as the ratio between the capacitance C of a parallel plates capacitor with a dielectric and

capacitance C_0 of the same capacitor with a vacuum. The relative permittivity depends on the type of material and physical conditions such as temperature, pressure and frequency.

$$\epsilon_r = \epsilon_r' - j\epsilon_r'' \quad (1)$$

The imaginary part of the relative permittivity ϵ_r'' (dielectric loss) is a parameter that determines the efficiency with which energy of the electromagnetic radiation can be converted into heat. The real part ϵ_r' is the dielectric constant that describes the ability of a molecule to be polarized in the electric field.

All industrial heating systems operate at a fixed frequency, or at most as combination of two frequencies. Therefore relative permittivity can be considered as a frequency independent parameter (frequency is constant). Figure 3 shows the relationship between the real part ϵ_r' and the imaginary part of the relative permittivity ϵ_r'' as a phase diagram [27].

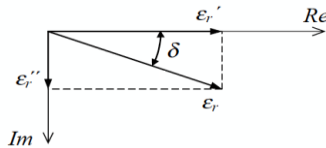

Figure 3: Complex relative permittivity

The ability to convert microwave energy into heat at a given temperature and frequency defines another parameter called the dielectric loss tangent or dissipation factor ($\tan \delta$):

$$\tan \delta = \frac{\epsilon_r''}{\epsilon_r'} \quad (2)$$

The materials with a higher value of $\tan \delta$ are capable to more efficient absorption of microwaves and, as a result, to more rapid heating [28].

3.2.2. Penetration depth

The penetration depth is the depth of the microwaves at which 63% of the initial energy is already converted to heat and the initial power is decreased to about 13 % (Figure 4). The theoretical value of the penetration depth can be calculated by the equation (3):

$$D_r = \frac{\lambda_0}{2\pi} \frac{\sqrt{\epsilon'}}{\epsilon' \tan \delta} = \frac{c_0}{2\pi f} \frac{\sqrt{\epsilon'}}{\epsilon''} \quad (3)$$

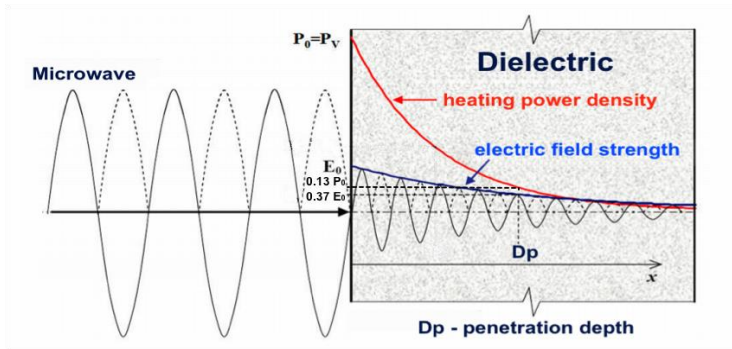

Figure 4: Penetration depth [modified 29]

The penetration depth is inversely proportional to $\tan \delta$ and depends significantly on temperature and frequency. Beyond the penetration depth, volumetric heating due to absorption of microwave energy becomes insignificant [23].

3.3. Microwave effects

There are some microwave effects, which cannot be duplicated by conventional heating and result mostly from the uniqueness of the microwave dielectric heating phenomenon.

Selective heating arises in a mixture of substances of different dielectric properties. The microwaves "select" these substances according to their absorption properties.

Volumetric heating with reversed temperature profile arises due to generation of efficient internal heating simultaneously in the whole volume of the material (in case of small particles). The highest temperature during the complete heating is in the core of the particle because the outer layer is cooled faster - the temperature profile is reversed.

Elimination of reactor wall effects occurs because MW directly heat the material and the temperature of reactor wall is lower than that of the material. This property prevents the deposition of incrustations, which are large problem in the conventional reactors.

Skin effect is the tendency to heating of the larger material particles at a limited depth, so that the microwaves do not efficiently heat the material core. This effect is closely related to the penetration depth of microwaves D_p .

Superheating is a phenomenon, which occurs in substances with extreme high loss tangents such as some ionic liquids. These substances can be heated far above its boiling point at atmospheric pressure in a short time [23].

Hot spot effect is a generation of places in volume of material that has a significant higher temperature than its surroundings. This high concentration of energy (spot) may be caused by inhomogeneity of the MW field or of the material (spots with higher MW absorption) as well as by the shape of material.

Thermal runaway is a local microwave-induced and self-directed overheating of the material, which increases exponentially with increasing temperature. The trigger for the thermal runaway is a "hot spot" [27].

Non-thermal effects are „accelerations of chemical transformations in a microwave field that cannot be rationalized by either purely thermal/kinetic or specific microwave effects“ [30]. The existence of non-thermal effects (also called not purely thermal and athermal effects) is still a pretty controversial topic.

4. Methods used in the dissertation

The aim of the work is to investigate some chosen applications of using microwaves in respect of energy recovery from waste especially referring to methane generation. These applications are divided in this paper into two main groups: microwave pre-treatment of sewage sludge prior to anaerobic digestion and microwave gasification of the different types of waste with subsequent microwave assisted oxidation of generated syngas.

4.1. Microwave application for sewage sludge pre-treatment

This part is based on the studies of Institut fuer Technologie und Umweltanalytik GmbH in Ebersbach (Germany) in cooperation with the University of Applied Sciences Zittau / Görlitz [10]. The aim of these experiments was to investigate whether this method is usable for sludge disintegration. The potential suitability of microwave disintegration for increasing the gas yield is then assessed in terms of energy balance and the comparisons with other similar investigations described in the literature. These experiments didn't directly investigate the biogas production after microwave irradiation.

4.2. Gasification and oxidation experiments

This part is based on the studies carried out by company Aton SA (Poland). The first objective was to obtain practical knowledge about the microwave gasification of waste and whether the syngas is generally suitable as a fuel for combustion engines. The second objective was to investigate the microwave-assisted oxidation of syngas in a microwave reactor (MOS) in order to reduction of emissions and for energy recovery. The gasification

of the waste was carried out in the laboratory microwave reactor ATON HR - Lab and the microwave-assisted oxidation of syngas took place in the reactor ATON MOS. The setup of the experiment series is shown in Figure 5 below. The investigated materials were scrap tyres, biomass (sawdust and pellets) and different plastic, biomass, rubber, foam from waste sorting.

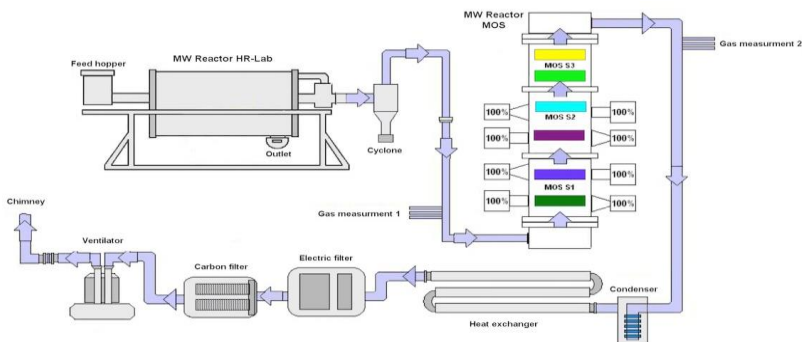

Figure 5: Layout of the experiments

Microwave reactor ATON HR (Figure 6) is a ceramic drum located within a metal casing with microwave transmitters fixed to its walls. Since the ceramics of the rotating drum does not absorb microwaves, the microwave energy is transmitted directly to the material. In the high temperature the material is decomposed in the non-oxidative atmosphere into different gases and solid residues.

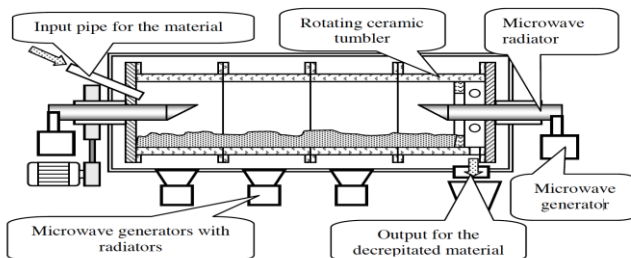

Figure 6: Scheme of microwave reactor Aton HR

The microwave reactor MOS is used in these experiments for the oxidation of the outlet gas of the gasifier. This reactor includes a reactor chamber in the form of a cylindrical container with a porous material bed, an inlet and outlet for exhaust gases and at least one microwave emitter connected to the microwave generator (Figure 7).

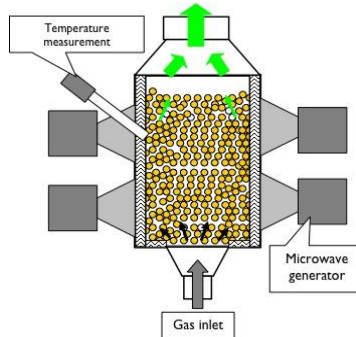

Figure 7: MOS reactor - principle of operation

The device is filled with special ceramic profiles in the form of ring which are a good microwave absorber and are heated by the microwaves to the temperature between 900 and 1500°C. The gases are heated in MOS reactor during the turbulent flow through the hot ceramic bed and by the oxidation reactions in the oxidizing environment. Because of sufficient amount of oxygen, the combustible gases and organic compounds undergo a quick oxidizing process (combustion). Strongly heated ceramic is an additional catalyst in the process of oxidation. The reactor may be connected to a heat exchanger for heat recovery from hot exhaust gases.

4.2.1 Oxidation of exhaust gases using reactor MOS

This experiment series were carried out to prove the suitability of the MOS reactor for cleaning of exhaust gases by an independent accredited testing laboratory - Quality Research Center Sp. z o. o. Lubin on behalf of the company Aton.

The tests included the measurements of gas composition and concentration of the each ingredient before and after processing by microwave reactor MOS. The results of these measurements are useful for the evaluation of the efficiency of microwave assisted gas cleaning and a potential use of this reactor as a part of the energy producing systems like CHP on basis of a gas engine.

5. Results of sewage sludge pre-treatment

The experiments with MW irradiation of waste sewage sludge indicate, that the moderate power causes visible effects on chemical, physical and biological sludge properties. Microwave disintegration seems to raise the biodegradability of excess sewage sludge considerable. The denitrification was visible accelerated already in the initial stage of microwave irradiation. Phosphate content increased significant even after irradiation with moderate microwave power of 400 W (increase by factor 8 at duration of 120 s). The results of the experiments indicate, that the first stage of sludge disintegration occurs also by lower microwave power of 580 W and irradiation time of 70 s. In this stage hydrolysis of large biopolymers to smaller particles as well as a partially destroying of some microorganisms resulting in increase solubility of sludge was observed, but not every cell walls were cracked. After 80 seconds with 580 W the rotifers were still vivid and active (Figure 9). Figure 8 shows sludge before microwave treatment for comparison.



Figure 8: Sludge before irradiation



Figure 9: Rotifer in sludge after 580W/ 80s

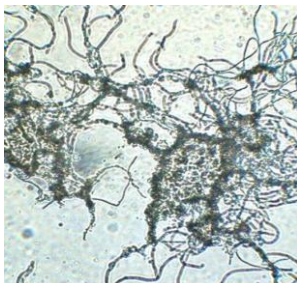

Figure 10: Sludge after 30s / 800W irradiation

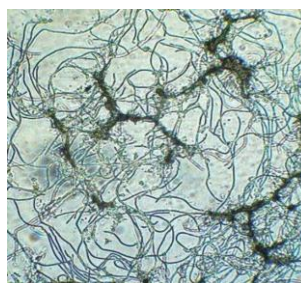

Figure 11: Sludge after 800W / 60s

Some microorganisms such as filamentous bacteria show a high resistance to MW and their destruction requires much larger energy inputs (Figure 10). It can lead to some

operational problems of sewage systems, which subsequent can cause a significant decrease of biogas generation. Figure 11 shows that filamentous microorganisms dominate in sludge already after 60 seconds of microwave irradiation with the power of 800 W. That is a likely reason for the observed floating up effect of sludge (Figure 12).



Figure 12: Floating up of sludge irradiated with 800 W

5.1. Energy considerations

Energy efficiency is a decisive factor in determining the economical feasibility of every industrial process. The amount of energy consumed for the generation of microwaves has to be reflected in an adequate increase in the biogas amount. For a positive energy balance the consumed energy has to be lower than the energy gain from increased biogas yield E_o . The energy consumption ratio (ECR) can be defined as:

$$ECR = \frac{E_i}{E_o} \quad (18)$$

E_i – specific energy input (energy consumption for microwave generation)

E_o – energy output resulting from elevated biogas production

The results of calculation show the highly negative energy balance with ECR values between 7.07 and 42.43. These values correspond to total dry substance but not to organic dry substance. Actually, the energy consumption ratio was by about 25% higher because biogas is only generated by conversion of organic matter. The next aspect when considering the energy efficiency of this process is the necessity of biogas preparation prior to use as an energy source. This worsens the already poor energy balance additionally.

6. Results of gasification and oxidation

In this part the results of the gasification of different waste are described such as scrap tires, biomass (wood pellets and sawdust) and some types of different sorted waste.

6.1. Scrap tires gasification

The LHV of raw material before gasification was detected at 38.839 MJ/kg. The content of carbon monoxide, hydrogen and methane and total amount of combustible components in syngas of 46% is reflected in the LHV of 14.888 MJ/m³ and indicates the possible use as a fuel for gas engines to energy production. The solid residues contain a very high amount of carbon (at above 99 %) and could be probably used for further processing into a high end product, for example as an aggregate for rubber-processing industry.

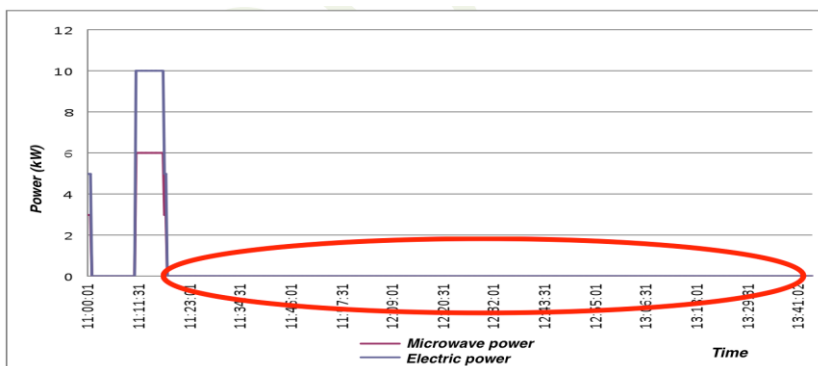

Figure 7-1: Power demand profile of the microwave reactor MOS

In the MOS reactor, where the oxidation of syngas took place, the microwave generators had worked only for a short time in the start-up phase, and were then switched off completely. Figure 7-1 shows that MOS had worked the most time in the auto-thermal modus without energy consumption for microwave generation. Remarkable is the very high efficiency of VOC oxidation in the reactor MOS which was at almost 100%. The measured concentration of VOC behind MOS was virtually zero, independent on input values (Figure 7-2).

Both microwave reactors could be used for energy recovery from scrap tyres and other types of waste (for example ASR). Figure 7-3 shows a block diagram of possible CHP application using gas engine and microwave reactors HR and MOS in order to recover heat energy and electricity.

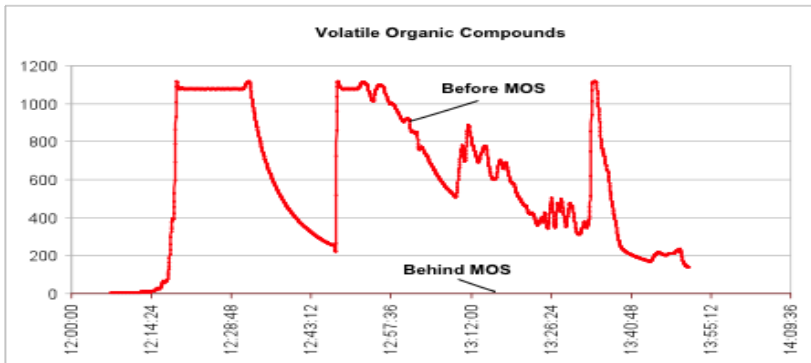

Figure 7-2: Oxidation efficiency of MOS

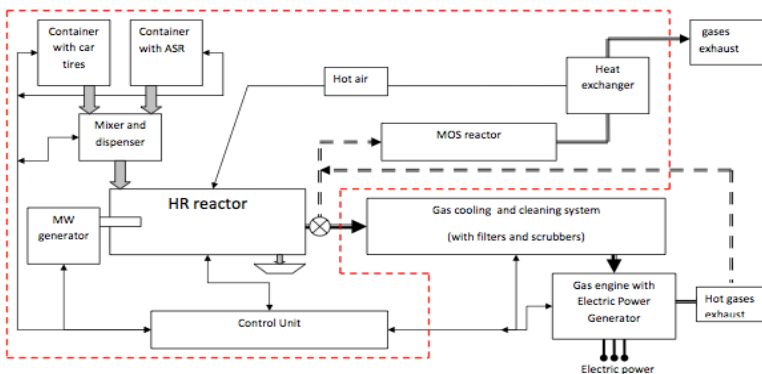

Figure 7-3: Block diagram of possible CHP system based on scrap tyres and ASR

6.2. Biomass gasification (sawdust and wood pellets)

The aim of the experiment was to determine the parameters of the process in the most optimal conditions for the formation of combustible gases in particular methane in the process gas in order to use it as a fuel for gas engines. For this reason sawdust and wood pellets were gasified at different temperatures. By far the best results were achieved in the gasification of wooden pellets at 800°C in the HR – Lab. The LCV of syngas was at 16.237 MJ/m³ and the gas mixture contained about 15% methane, 38% carbon monoxide, 19% hydrogen and 3% ethane + ethane (in total 75% of combustible gases), which is an indication for a good suitability for gas engines.

In the process carried out in HR - LAB with wood pellets at 800-850 °C was formed a much higher content of combustible gas compounds in relation to the other trials. The reason for substantial increasing of the methane content, carbon monoxide and hydrogen was among others the reduction of the oxygen content inside of the small reactor and subsequent preventing of oxidation processes.

The calculations of volumetric flow rates shown, that from gasification of 1 kg of biomass in form of wood pellets at the weight-loss of 75% about 2.92 m³/kg of humid gas at real conditions (750°C, 100 kPa) can be obtained, what results converted a gas volume of 0.55 m³_N/h dry gas (at 273 K, 101.325 kPa). This syngas had a high calorific value of 16.2 MJ/m³ and is considered to be a good quality fuel that is suitable for use in gas engines. The syngas had also a high content of tar and dust therefore in order to avoid malfunctions and accelerated wear a conditioning is necessary. An example of treatment system for syngas shows Figure 7-4 below.

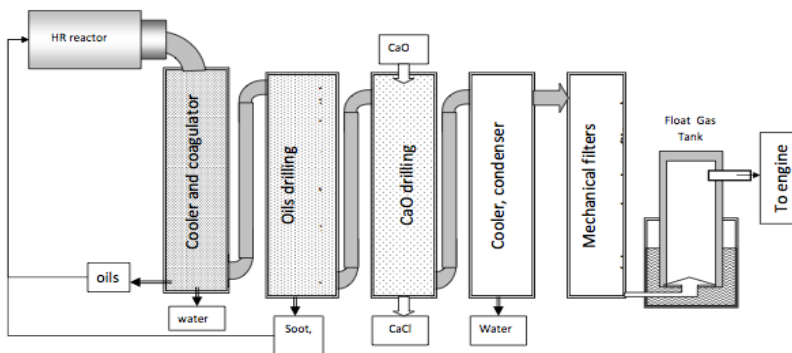

Figure 7-4: Example of syngas treatment system

6.3. Gasification of different waste samples

For this part of the work 20 different waste samples were in detail analyzed, then gasified in the microwave reactor VR-Lab. In the microwave reactor was trying to keep the oxygen content as low as possible, to enable the precise detection of the energy content of the process gases. The aim of the study was to investigate the suitability of the objective method for the production of fuel gas from waste using microwave technology.

The second microwave reactor in the system, the MOS, has played a double role. On the one hand it carried out the oxidation of the gases produced by gasification efficiently and

in controlled way. On the other hand it was investigated whether this type of reactor is also suitable as arrangement for exhaust gas cleaning from combustion processes.

Figure 7-5 shows an example of the courses of CH₄ and H₂ generation during the gasification of sample AIP_06/8, which had in raw state the mean calorific value of about 21 MJ/kg.

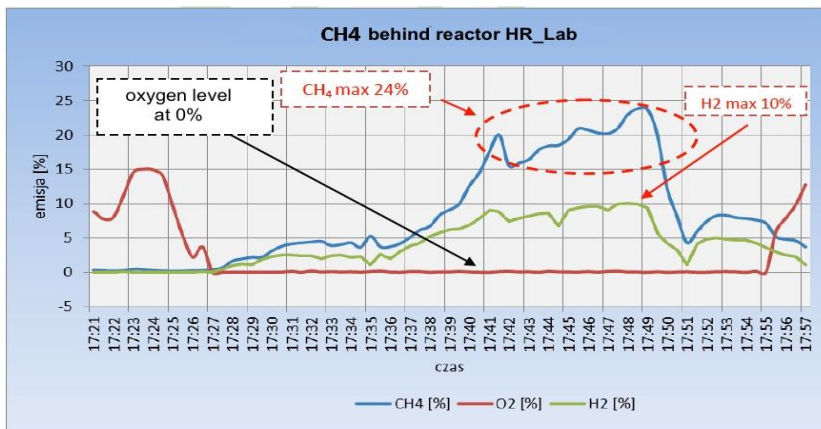

Figure 7-5: Example of methane course from sample AIP_06/8 at 850°C

The achieved concentration of methane up to 24 % and hydrogen up to 10 % could indicate a good calorific value of syngas. The mean LHV of solid residues after gasification was only about 5 MJ/kg, what means that the energy released in the process was about 16 MJ/kg in form of gaseous components. The diagram shows clearly the dependence of methane and hydrogen production on oxygen concentration in the reactor – it is visible that the concentration of these gases had begun to increase after the oxygen level had dropped down to 0%. Based on these values could be concluded, that this method is suitable for energy generation from this kind of waste and produce syngas of high quality, because of the low HCV of solid residues.

6.3.1 Oxidation and cleaning of exhaust gases

The oxidation of the gases, which were produced in the gasification reactor HR-Lab was carried out in the MOS reactor. In order to allow the oxidation of gas components, it is important to provide sufficient amount of oxygen and to control the temperature in reactor. Figure 7-6 below shows the typical chart of the measurements of CO concentrations before and after the MOS processing (sample AIP_06 / 01 at 550°C). The energy

consumption of the microwave generators was depending on the chemical energy of the processed gases. During the oxidation of exhaust gases with a high content of combustible components, the microwave generators have little power consumed and often were also partially switched off completely and the process went autonomously through the use of the chemical energy of the gases.

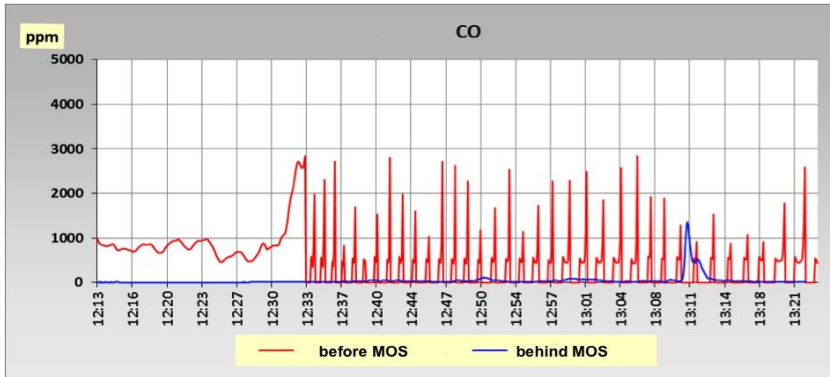

Figure 7-6: Course of CO before and behind MOS

6.3.2 Discussion of the results

The most materials had a considerably large calorific value and the methane concentration in the produced gas was high. The calorific value of the solid residues after gasification of some samples was above 32 MJ/kg (AIP_06/02, AIP_06/16), what is also a very high value and makes possible to use this material for further energy production by combustion. From these samples previously more than 30% methane was already recovered. Of the 20 samples analyzed, only five of them had a heating value below 6 MJ/kg and would be suitable for landfilling, according to legislation [31].

The material moisture seems to have a special influence on the process efficiency. For this reason the material should be prepared prior to gasification. The experiments show also, that in the initial stage of the MW reactor operation the process was instable and consumed more microwave energy, therefore another low-cost heating source should be used, until the inside temperature is reached. The using of hot reactor has another important advantage - the thermal runaway effect of microwave heating could support the gasification process.

The next important precondition for desirable running of the process is the oxygen content, which affects very quickly the concentrations of methane, hydrogen and carbon

monoxide and subsequent also the calorific value of the syngas. Therefore it is important to monitor and control the oxygen amount very closely. Some materials like foams have to be prepared before gasification, due to increase their density and reduce hygroscopic properties.

The detection of temperature in the outlet gases from the microwave reactor by thermocouple used in the experiments is only an approximation that allows obtaining of the preliminary findings and tendencies. The real temperature of the processed material can certainly reach significantly higher values.

The process temperature can affect the tar formation - with increasing temperature the amount of tar in the syngas decreases. This confirmed also the experiments with the gasification of biomass. In the studied temperature range, only a reduction and no removal of tar can be expected. The reduction of tar amount through higher gasification temperature, however, causes higher energy consumption and higher heat losses. This fact should be taken into account in the choice of the gasification temperature.

The auto-thermal mode is relatively easy to implement in this system. The prerequisite is that the material has a sufficiently high calorific value and offers good converting microwave energy into heat.

The moisture content reduces the caloric value and causes higher energy consumption for microwave generation; hence the moisture should be reduced accordingly prior to gasification. Since the amount of oxygen plays an important role in the process, this should be very closely monitored. The lambda value could be in the range of about 1.1 but the precise adjustment must be carried out during operation. All equipment should be tight in order to prevent the suction of air. Especially the loading device must be carefully planned and adapted to the material.

6.4. Oxidation of different gas components by reactor MOS

The results listed below are provided by an independent testing laboratory - Quality Research Center Sp. z o. o. Lubin / Poland on behalf of Aton S.A.

The maximum temperature of the process achieved 1000°C. The oxygen content was between 16.6 and 21 %, which indicates sufficient oxidation of the gas components. The measured concentration of CO behind MOS was in the first stage between 3 and 15 ppm and later dropped to about 8 ppm. The NO_x concentration fluctuated between 3.8 and 14 ppm. Overall, the course of the process was stable and has delivered very good results that have confirmed the earlier experiences. The results of the test have proven, that the

microwave reactor MOS is able to clean outlet gases from gasification and other industry processes with a very high efficiency. The oxidation was very efficient and the reduction tested for the ten on twelve gas components exceeds 99% (as shown in Table 1).

Table 1: Efficiency of oxidation by reactor MOS

GAS COMPONENT	AVERAGE EMISSION [kg/h]		REMOVAL EFFICIENCY [%]
	BEFORE MOS	AFTER MOS	
Sulfur dioxide (SO ₂)	0.0337	0.0029	91.3
Hydrogen sulfide (H ₂ S)	0.1694	not detected	99.9
Carbon monoxide (CO)	0.0733	0.0004	99.5
Buthanol (C ₄ H ₉ OH)	0.0013	0.000004	99.7
Toluene (C ₇ H ₈)	0.0051	not detected	99.9
Xylene (C ₈ H ₁₀)	0.0001	not detected	99.9
Benzene (C ₆ H ₆)	0.0037	not detected	99.9
Aromatic hydrocarbons	0,0091	not detected	99,9
Acetone (C ₃ H ₆ O)	0,000010	0,000002	79,3
Butyl acetate (C ₆ H ₁₂ O)	0.0032	not detected	99,9
Aliphatic hydrocarbons	0.1404	not detected	99.9
Ethyl benzene (C ₈ H ₁₀)	0.0002	not detected	99.9

The system removes efficiently the hydrocarbons and sulphur compounds from the exhaust gas. However, a separate device for the removal of nitrogen oxides is still required and the corresponding technical solutions are well known. Due to the high efficiency in the removal of different hydrocarbons, the use of this system for the oxidation of various tar compounds would be also feasible.

7. Conclusions

7.1. Potential of microwave-pre-treatment of sludge to increasing of the biogas yield of the digestion process

The experiments have shown, that microwaves pre-treatment can significant affect the sewage sludge properties and causes the disintegration of sludge also at moderate irradiation. The calculation of energy balance indicates that microwave disintegration only to increase of biogas yield is highly inefficient. The experiments did not include directly measuring of the biogas amount after MW pre-treatment. The energy balance alone shows already that this method is probably not feasible in industrial scale and the literature and reports of other experiments seems indirectly to confirm this conclusion.

In the literature energy balances of microwave pre-treatment can be find in respect to other types of biomass. PASSOS ET AL. [32] investigated increase of biogas production from microalgae grown in wastewater by microwave pre-treatment. The specific energy input was between 21.8 and 65.4 MJ/kg TS. The results of energy consumption ratio calculations (E/E_0) were also very poor between 33.3 and 69.9. BESZÉDES ET AL. [33] assayed the influence of MW and ozone pre-treatment and presented that the microwave irradiation alone had no significant effect on the biogas generation, regardless of applied energy.

Generally, sewage sludge consists primarily of water and, compared to conventional methods, heating of water by microwaves is not efficient. The efficiency of the process could be significant increased by reducing of water content of the sludge before MW treatment, and that is very energy intensive. One of the reasons for the poor energy balance could be the low penetration depth of microwaves in water solutions. This microwave effect causes a temperature gradient where the outer layer of water has a significant higher temperature than the core of the vessel. The specific MW effects should definitely be considered in the selection of the experimental design in the future. Thus, e.g. the sample size and the shape of the vessel as well as water content have an influence on the results and the efficiency of the microwave processes.

In the experiments, after the irradiation of 800 W was found that the balance of microorganisms is changed and the filamentous bacteria dominated and contribute to floating up of the sludge. This is an undesirable phenomenon that may contribute to different operational problems and cause the decrease of biogas yield significantly.

7.2. Potential of microwave gasification for energy recovery from waste

The experiments show clearly, that gasification of waste in the microwave reactor is a possible way to obtain a gas mixture with high energy content, which could be used as a fuel for gas engines.

The gasification experiments have shown a further important advantage of microwave technology, which is the insensitivity of the reactor against tar. Many reports of pyrolysis and gasification emphasize the problem with tar deposits and encrustation on the reactor walls. The fact that tar is not deposited on the reactor walls does not mean that no tar is produced. As soon as the temperature decreases accordingly starts the deposition of tar. Therefore, additional measures are needed for tar removal. It is likely that the microwaves change the settling behaviour of tars in the reactor but about their creation there is no established findings. The impact of microwaves on tar formation has not been studied in this work; therefore final conclusions on this issue cannot be drawn. However, there are some indications that the microwave in conjunction with the ceramic reactor can have a positive influence on tar formation. That would be an interesting subject for further studies.

The microwave generation requires large amounts of electrical energy to convert the chemical from waste. The only way to reduce the energy consumption is an auto-thermal process, where the microwave heating triggers the gasification and the energy released from waste maintains the process. Since microwaves are ideal for the control of gasification they would be only switched on when the process requires it.

The physical properties of MW have not only benefits but also disadvantages which considerable limit their applications. For example, the small penetration depth limits the applications on materials with relative small particles, so the processed material has to be prepared accordingly before gasification. Low moisture content is the next important precondition of the processed material, due to the selective heating of the microwaves. The next physical property of microwaves that limits the size of the reactor is the wavelength. Thus in the interior of the reactor can occur an optimum density of the electromagnetic field, the reactor should not exceed appropriate dimensions. This means that the scaling of reactors is limited by the physical properties of microwaves. The high carbon and energy content of the solid residues indicates the need of further action because the landfilled waste cannot exceed the value of 6 MJ/kg. An auto-thermal operation in addition to reduction of energy consumption could decrease the carbon content in solid residues due to partial oxidation.

7.3. Potential of microwave indirect heating to energy recovery and to cleaning of exhaust gases

Indirect heating is the only way to process gases by microwaves, because gases are virtually transparent for electromagnetic waves. The indirect microwave heating is represented in this work by microwave reactor MOS (Microwave Oxidation System) which is filled with special ceramic round profiles (rings) with a diameter of 50 mm. These rings convert microwave into heat very efficient and can reach the temperature up to 1500°C. The ceramic profiles have a large contact area and the gases are heated rapidly to high temperatures during the turbulent flow through the hot ceramic bed due to convection and the oxidation reactions, which take place in the reactor. The reactor is connected to a heat exchanger, which allows further use of generated heat energy.

The results of all experiments with this system were very promising. The tests have demonstrated a high efficiency of the cleaning effect of many harmful gas components that reached in some cases 99.9 %. In addition the gases achieve very high temperatures during operation and carrier a high amount of heating energy. The heat exchanger can capture this energy and provide to use for other purposes.

The reactor is very insensitive to various gas components and can burn highly polluted gases with a high calorific value, clean them and gain the heat energy from these oxidation processes. The combustion of the processed gases is carried out after dedusting, without further preparation. These features make this reactor into an independent energy producer from the combustion of burnable gases, which cannot be used by other methods because of their properties and composition.

The heat can either be used directly in other processes or be converted to electricity by means of ORC system. Such system can generate energy surplus and achieve a positive energy balance. One of the most important preconditions for process economy is a sufficient energy content of processed waste, which should be higher then 15 MJ/kg.

The next possible and valuable application of this system could be decomposition of tars in process gases. This application would in addition to solution of tar problem increase the heating value of processed gas.

Microwave assisted oxidation seems in general to be a very promising technique and could be a foundation of some innovative applications. Further investigations in different areas are recommended that could deliver valuable information about potential and limitations of this method.

8. Summary

This thesis deals with different aspects of energy recovery from waste using microwave technology. Three approaches are discussed: impact of microwave pre-treatment of sewage sludge (as a form of biomass) on methane yield from anaerobe digestion, gasification of various waste by direct microwave heating and microwave assisted oxidation of syngas components (indirect MW heating).

The experiments with MW pre-treatment of sewage sludge have shown, that microwave irradiation can cause the disintegration of sludge also at relative moderate power. Microwave disintegration seems to raise the biodegradability of excess sewage sludge considerable and accelerate some biological processes. However, the irradiation with higher power caused a significant increase of filamentous microorganisms, which resulted in floating up of sludge. This phenomenon could negative influence the operation of sewage plants and subsequently decrease the methane yield. The evaluation of energy ratio has shown, that this method is highly inefficient and the expected increase of methane yield can never compensate the expenditure of energy. For this reason this method cannot be recommended only in order to increase energy yield from anaerobic digestion.

The second series of experiments examined gasification of different waste samples by MW gasifier. The aim of these experiments was to evaluate, whether gas produced by microwave reactor could be used as a fuel for gas engines. The gas quality and the caloric values from the most samples were suitable for gas engines. For economic reasons the microwave reactor should work in the auto-thermal modus, where a part of the produced gas is oxidised in reactor and generates heat to maintain the operation with minimised use of microwave energy. In this case microwaves are used only for process control.

The capacity of the MW reactor is limited by the properties of microwaves and the up-scaling is difficult. Therefore the use of this technology seems to be limited to small scale. The investigation of proper condition for auto-thermal process and up-scaling of this technology would be a good extension to this work.

The experiments with the gas oxidation in MOS (Microwave Oxidation System) have delivered some interesting results. In this system microwave irradiation heats the ceramic filling of the reactor up to 1500°C and causes a very efficient oxidation of the gas compounds (up to 99.9%). This system can also recover the heat energy from the oxidation by heat exchanger and provide this energy for further processes or to generation

of electricity by ORC. This microwave application is very promising and would be an interesting issue for further investigations.

The experiments shown, that an auto-thermal operation of the system can be easily achieved when the oxidation of processed gases provides sufficient energy. The microwave generators are used in this case only to control the process temperature and are automatically switched on when the temperature drops below preset value.

In general, to investigate the potential of microwave application it is necessary first to deal with the specific microwave effects, which cannot be achieved with conventional heating methods. Some properties could be very useful in the waste processing like direct heating of the material and the high velocity of operation. On the other hand there are properties that are not always very helpful and can also complicate many applications or even make them impossible. Therefore, it is very important, in the planning of microwave applications or laboratory experiments as well as for evaluation of these experiments to understand and to consider these specific properties.

References:

- [1] EUROPEAN UNION (2010): Being wise with waste: the EU's approach to waste management, Publications Office of the European Union, Luxemburg, ISBN: 978-92-79-14297-0
- [2] GENDEBIEN A. (2008): Environmental, economic and social impacts of the use of sewage sludge on land. Summary Report 1, Assessment of Existing Knowledge, Milieu Ltd, WRc and RPA for the European Commission, Brussel, Belgium
- [3] SIENKIEWICZ M. ET AL. (2012): Progress in used tyres management in the European Union: a review, Waste Management, 2012/32/10, P. 1742-1751
- [4] EUROPEAN COMMISSION (2012): Guidance on the interpretation of key provisions of Directive 2008/98/EC on waste, available at: http://ec.europa.eu/environment/waste/framework/pdf/guidance_doc.pdf
- [5] EUROPEAN COMMISSION (2014), Web site of European Commission, accessed December 2014, available at: http://ec.europa.eu/environment/waste/landfill_index.htm
- [6] BIO INTELLIGENCE SERVICE (2011), Implementing EU Waste Legislation for Green Growth, Final Report prepared for European Commission DG ENV
- [7] UNITED STATES ENVIRONMENTAL PROTECTION AGENCY (2014), Overview of Greenhouse Gases, accessed December 2014, available at: <http://epa.gov/climatechange/ghgemissions/gases/ch4.html>
- [8] DEFRA - DEPARTMENT FOR ENVIRONMENT, FOOD AND RURAL AFFAIRS (2011), Anaerobic Digestion Strategy and Action Plan, Ref.: PB13541
- [9] MONTGOMERY L. F. R., BOCHMANN G. (2014), Pretreatment of feedstock for enhanced biogas production, IEA Bioenergy, ISBN 978-1-910154-05-2
- [10] GIEMZA M. (2013): Nowy sposób dezintegracji osadu ściekowego? Podsumowanie prób laboratoryjnych z zastosowaniem techniki mikrofalowej, Technologia Wody, 10/2013, P. 28-33
- [11] ZIEMINSKI K., FRAC M. (2012), Methane fermentation process as anaerobic digestion of biomass: Transformations, stages and microorganisms, African Journal of Technology, Vol. 11(18), P. 4127-4139, ISSN 1684-5315
- [12] KLINGSPOR G. ET AL. (2013), Mit Ultraschalltechnik zur effizienten Kläranlage, WWT - Wasserwirtschaft Wassertechnik, 10/2013, P. 26-29
- [13] EUROSTAT (2013): Environment in the EU-27, Eurostat news release, 33/2013

- [14] GOODSHIP V. (2010): Management, recycling and reuse of waste composites, Woodhead Publishing, Cambridge, UK, ISBN 978-1-84569-462-3
- [15] DEFRA - DEPARTMENT FOR ENVIRONMENT FOOD & RURAL AFFAIRS (2013): Advanced Thermal Treatment of Municipal Solid Waste, available at: www.gov.uk.defra
- [16] EUROPEAN COMMISSION (2006): Integrated Pollution Prevention and Control, Reference Document on the Best Available Techniques for Waste Incineration, August 2006, available at: http://eippcb.jrc.ec.europa.eu/reference/BREF/wt_bref_0806.pdf
- [17] BUND FÜR UMWELT UND NATURSCHUTZ DEUTSCHLAND (BUND) (2010): Wege zu einer nachhaltigen Abfallwirtschaft, Bund Positionen, 49/2010
- [18] MORRIS J. (1996): Recycling versus incineration: an energy conservation analysis, Journal of Hazardous Materials, 47/1996, P. 277-293.
- [19] ENCYCLOPAEDIA BRITANNICA (2014), accessed September 2014, available at: <http://www.britannica.com/EBchecked/topic/484978/pyrolysis>
- [20] JANÍČEK F. ET AL. (2007): Renewable Energy Sources 1, Technologies for a Sustainable Future, Faculty of Electrical Engineering and Information Technology, Bratislava, P.90-91, ISBN 978-80-969777-0-3
- [21] ARENA U. (2012): Process and technological aspects of municipal solid waste gasification, Waste Management 32/2012, P. 625–639
- [22] HAN J., KIM H. (2008): The reduction and control technology of tar during biomass gasification / pyrolysis: An overview, Renewable and Sustainable Energy Reviews, V.12, I. 2, P. 397-416
- [23] KAPPE C. O. ET AL. (2009): Practical Microwave Synthesis for Organic Chemists, WILEY-VCH Verlag GmbH & Co. KGaA, Weinheim, Germany, P. 11-43, ISBN: 978-3-527-32097-4
- [24] HAQUE K.E. (1999): Microwave Energy for mineral treatment processes – a brief review, International Journal of Mineral Processing, Vol. 57, P. 1 – 24
- [25] REICHMANN, M. (2011): Dissertation: Auslegung von Mikrowellen-Thermoprozess-Anlagen unter Nutzung von hochfrequenz-technischen Prinzipien - am Beispiel eines Entbinderungssofens für keramische Grünkörper, Technische Universität Bergakademie Freiberg, Germany
- [26] TSUJI, M. ET AL. (2005): Microwave-assisted synthesis of metallic nanostructures in solution, Chemical European Journal, 11, P. 440-452
- [27] BURYAN M. (2004): Dissertation: Entwicklung von Auslegungsprinzipien für mikrowellen- und gasbeheizte Hybrid-Sinteröfen, Technische Universität Bergakademie Freiberg, Germany

- [28] HAYES, B. L. (2002): Microwave synthesis, chemistry at the speed of light; CEM Publishing: Mathews, NC
- [29] WILCK S. (2011): Dissertation, Veredelung von Eisenhydroxisulfaten aus Tagebauwässern durch Anwendung von Mikrowellenenergie, Fakultät III der Technischen Universität Berlin, Germany
- [30] KAPPE, C.O. (2004) Angewandte Chemie- International Edition, 43, 6250–6284.
- [31] Deponieverordnung (2009), Verordnung über Deponien und Langzeitlager, (DepV Ausfertigungsdatum: 27.04.2009), BGBl. I Nr. 22 vom 29.04.2009
- [32] PASSOS F. ET AL. (2013), Biogas production from microalgae grown in wastewater: Effect of microwave pretreatment, Applied Energy, 108 (2013), P. 168 – 175
- [33] BESZÉDES S. ET AL. (2009), Enhancement biogas production of canned maize production sludge by ozone and microwave pretreatments, Series Chemistry, 18 (2) (2009), P. 1-8

Publications of the author:

1. GIEMZA M. (2013): Nowy sposób dezintegracji osadu ściekowego? Podsumowanie prób laboratoryjnych z zastosowaniem techniki mikrofalowej, *Technologia Wody*, 10/2013, P. 28-33, Wydawnictwo Seidel-Przywecki, Poland, ISSN 2080-1467
2. GIEMZA M. (2013): Dezintegracja ultradźwiękowa w oczyszczalniach ścieków, *Technologia Wody*, 11/2013 (31), P. 31-35, Wydawnictwo Seidel-Przywecki, Warszawa, Poland, ISSN 2080-1467
3. GIEMZA, M. (2013): Leadership in Projects, Paper of the Leadership Symposium, Arona, Berlin, Germany, P. 39-48, ISBN: 978-3-86468-620-7
4. GIEMZA, M. (2014): Using of Microwave Technology for Thermal Processing of Municipal Waste, Paper of the Symposium Business visions for sustainable development, Arona, Berlin, Germany, P. 24-45, ISBN: 978-3-86468-850-8